

article#	9224-6
article description	CEE-wall mounted socket + safety socket COMBO 32A 4p 6h IP44
description long	CEE-wall mounted socket + safety socket COMBO 32A 4p 6h IP44 housing material: PA6 rated current: 32A number of poles: 4 (3P+PE) clock-position: 6h rated voltage/frequency: 380-415V~ / 50+60Hz contacts: brass connection technology: screw terminals cable entry: top, 2x bottom, rear with safety socket (Austrian/German standard) - ready wired IP protection class: IP44 safety socket (for 32A version) protected by fuse 10A slow
GTIN (EAN)	9003399094880
country of origin	AT
customs number	85366990
net weight	0.470 kg
packaging quantity	5
minimum order quantity	5

ETIM 9.0	EC000379
CEE socket outlet 32 A	1x32A xp xxxV
Number of socket outlets with protective contact CEE 7/3 (type F)	1
Material housing	Plastic
Handling	Wall mounting
Degree of protection (IP)	IP44
Colour	Grey

a	188 mm
b	136 mm
wire flexible	2,5-6 mm ²
wire solid	2,5-10 mm ²
contact screws	110 Ncm
housing screws	110 Ncm
connecting screws	110 Ncm
dismantling length	50 mm
stripping length	12-14 mm

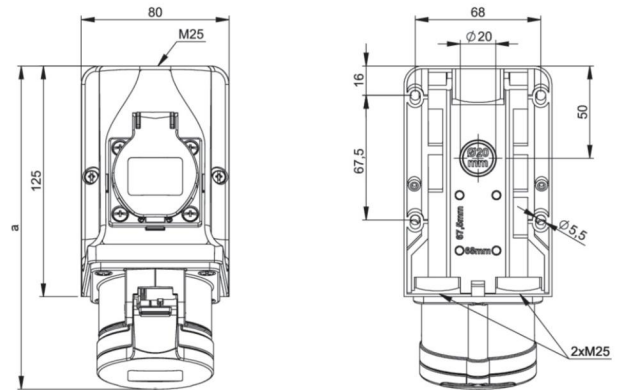

b=Höhe/height
Neigung/angle=15°



<https://www.pcelectric.at/shop/en/?func=detail&artnr=9224-6>