

article#	7625-6
article description	CEE-switched interlocked socket DIN 32A 5p 6h IP44/IP54
description long	CEE-switched interlocked socket DIN 32A 5p 6h IP44/IP54 housing material: PC/ABS rated current: 32A number of poles: 5 (3P+N+PE) clock-position: 6h rated voltage/frequency: 200/346V~ - 240/415V~ / 50+60Hz contacts: brass nickel plated connection technology: screw terminals wall mounting, mechanical interlock, hinged window (5 modules), DIN-rail switch: ON/OFF PCE-Merz ML0; EN 60947-3; AC22A, 10kA cable entry: top, bottom or rear (incl. threaded blind cap) IP protection class: IP44/IP54
GTIN (EAN)	9003399165764
country of origin	AT
customs number	85366990
net weight	1.617 kg
packaging quantity	1
minimum order quantity	1

ETIM 9.0	EC001324
IEC-amperage	32 A
Number of poles	5
Voltage according to EN 60309-2	400 V (50+60 Hz) red
Clock hour position	6 h
Identification colour	Red
Degree of protection (IP)	IP54
Switch	Mechanical locking
Empty locations on mounting rail	True
Material housing	Plastic
Model	Base unit and cover
Protection	None
Contact material	CuZn
Surface treatment contacts	Nickel-plated

a	369 mm
b	153 mm
wire flexible	2,5-6 mm ²
wire solid	2,5-10 mm ²
contact screws	120 Ncm
housing screws	110 Ncm
ambient temperature	-25 – 40 °C
temperature resistance	-25 – 80 °C

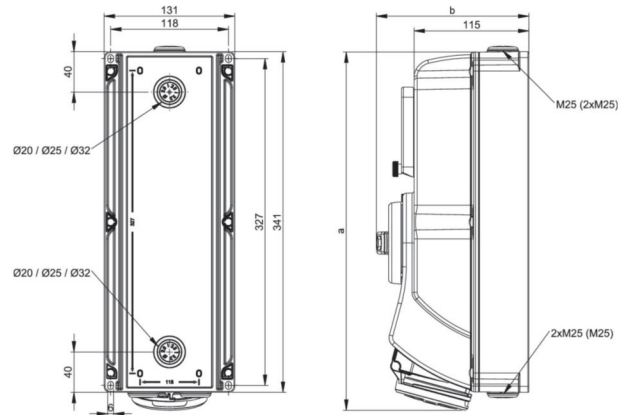

<https://www.pcelectric.at/shop/en/?func=detail&artnr=7625-6>