

article#	682-2v
article description	CEE-flanged plug straight 70x70mm 16A 2p 24/42VAC 300Hz IP44 TWIST
description long	CEE-flanged plug straight 70x70mm 16A 2p 24/42VAC 300Hz IP44 TWIST housing material: PA6 rated current: 16A number of poles: 2 (2P) clock-position: 2h rated voltage/frequency: 24/42V~ / 300Hz contacts: brass nickel plated connection technology: screw terminals dimensions (flange/fixing center): 70x70 mm / 56x56 mm IP protection class: IP44
country of origin	AT
customs number	85366990
packaging quantity	10
minimum order quantity	10

ETIM 9.0	EC001319
IEC-amperage	16 A
Voltage according to EN 60309-2	20-25 V / 40-50 V (300 Hz) green
Number of poles	2
Clock hour position	2 h
Identification colour	Green
Degree of protection (IP)	IP44
Connection system	Screwed terminal
Construction type	Built-up device plug
Angle of plug	Straight
Material	Plastic
Contact material	CuZn
Surface treatment contacts	Nickel-plated

a	70 mm
b	70 mm
c	56 mm
d	56 mm
e	19 mm
f	28 mm
g	5 mm
h	43 mm
wire flexible	4-10 mm ²
wire solid	4-10 mm ²
contact screws	110 Ncm
dismantling length	70 mm
stripping length	14-16 mm
ambient temperature	-25 – 40 °C
temperature resistance	-25 – 80 °C

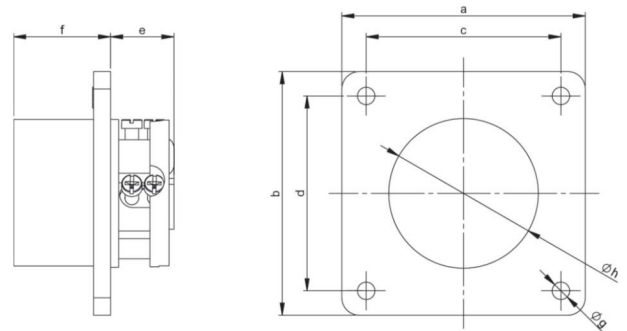





<https://www.pcelectric.at/shop/en/?func=detail&artnr=682-2v>