

article#	<b>3922-10f9v</b>
article description	<b>CEE-flanged socket straight 54x60mm 32A 2p 24/42VDC IP66/IP67 TWIST</b>
description long	CEE-flanged socket straight 54x60mm 32A 2p 24/42VDC IP66/IP67 TWIST housing material: PA6 rated current: 32A number of poles: 2 (2P) clock-position: 10h rated voltage/frequency: 24/42V DC contacts: brass nickel plated connection technology: screw terminals dimensions (flange/fixing center): 54x60 mm / 44x44 mm IP protection class: IP66/IP67
GTIN (EAN)	9003399308512
country of origin	AT
customs number	85366990
net weight	0.130 kg
packaging quantity	10
minimum order quantity	10

ETIM 9.0	EC001317
IEC-ampereage	32 A
Voltage according to EN 60309-2	<50 V DC grey
Number of poles	2
Clock hour position	10 h
Identification colour	White
Degree of protection (IP)	IP67
Connection system	Screwed terminal
Angle of plug	Straight
Material	Plastic
Contact material	CuZn
Surface treatment contacts	Nickel-plated
Flange size vertical	60 mm
Drill hole distance vertical	44 mm
Flange size horizontal	54 mm
Drill hole distance horizontal	44 mm

a	54 mm
b	60 mm
c	44 mm
d	44 mm
e	19 mm
f	48 mm
g	5,5 mm
h	43 mm
i	100 mm
j	93 mm
wire flexible	1-10 mm <sup>2</sup>
wire solid	1,5-10 mm <sup>2</sup>
contact screws	160 Ncm
dismantling length	70 mm
stripping length	14-16 mm
ambient temperature	-25 – 40 °C
temperature resistance	-25 – 80 °C

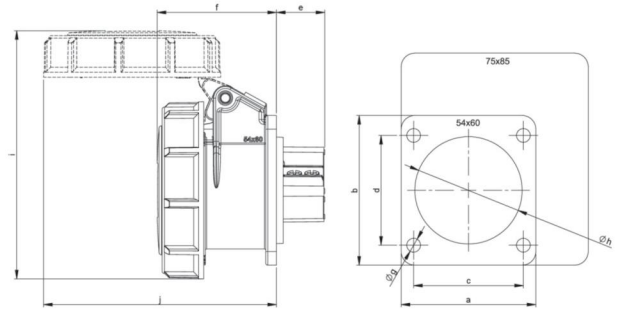





<https://www.pcelectric.at/shop/en/?func=detail&artnr=3922-10f9v>

