

article#	2922-12v
article description	CEE-connector 32A 2p 42VAC 50/60Hz IP67 TWIST
description long	CEE-connector 32A 2p 42VAC 50/60Hz IP67 TWIST housing material: PA6 rated current: 32A number of poles: 2 (2P) clock-position: 12h rated voltage/frequency: 42V~ / 50+60Hz contacts: brass nickel plated connection technology: screw terminals IP protection class: IP67
GTIN (EAN)	9003399059834
country of origin	AT
customs number	85366990
net weight	0.203 kg
packaging quantity	10
minimum order quantity	10

ETIM 9.0	EC001320
IEC-amperage	32 A
Number of poles	2
Voltage according to EN 60309-2	40-50 V (50+60 Hz) white
Clock hour position	12 h
Identification colour	White
Degree of protection (IP)	IP67
Connection system	Screwed terminal
Angle of plug	Straight
Cable entry	Gland nut
Material	Plastic
Contact material	CuZn
Surface treatment contacts	Nickel-plated

a	150 mm
b	78 mm
K (cable Ø)	9,5-24 mm
SW	48 mm
wire flexible	1-10 mm ²
contact screws	160 Ncm
strain relief	600 Ncm
dismantling length	70 mm
stripping length	14-16 mm
ambient temperature	-25 – 40 °C
temperature resistance	-25 – 80 °C
IK-code *)	IK08

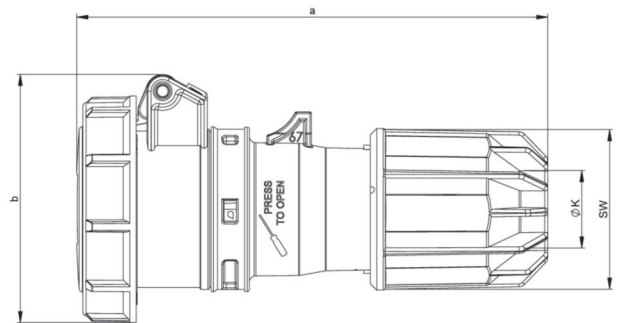

*) The IK-test is not part of the IEC 60309 standard for industrial plugs and socket-outlets or the IEC 60884 standard for household plugs and socket-outlets. PC Electric GmbH has therefore tested the IK-codes of these products in accordance with IEC 62262 and according to the test method of IEC 60068-2-75 Ehc, with conditioning for 48 hours at 40°C and a relative humidity of 95%.



<https://www.pcelectric.at/shop/en/?func=detail&artnr=2922-12v>