

article#	1932-3v
article description	CEE-wall mounted socket 32A 3p 24/42VAC 400Hz IP66/IP67 TWIST
description long	CEE-wall mounted socket 32A 3p 24/42VAC 400Hz IP66/IP67 TWIST housing material: PA6 rated current: 32A number of poles: 3 (3P) clock-position: 3h rated voltage/frequency: 24/42V~ / 400Hz contacts: brass nickel plated connection technology: screw terminals IP protection class: IP66/IP67
country of origin	AT
customs number	85366990
packaging quantity	10
minimum order quantity	10

ETIM 9.0	EC001321
IEC-ampereage	32 A
Number of poles	3
Voltage according to EN 60309-2	20-25 V / 40-50 V (400 Hz) green
Clock hour position	3 h
Identification colour	Green
Degree of protection (IP)	IP67
Connection system	Screwed terminal
Cable entry	Gland nut
Material	Plastic
Contact material	CuZn
Surface treatment contacts	Nickel-plated
Type of fastening	External mounting
Insulated mounting	True

a	143 mm
b	95 mm
wire flexible	1-10 mm ²
wire solid	1,5-10 mm ²
contact screws	160 Ncm
connecting screws	110 Ncm
dismantling length	70 mm
stripping length	14-16 mm
ambient temperature	-25 – 40 °C
temperature resistance	-25 – 80 °C

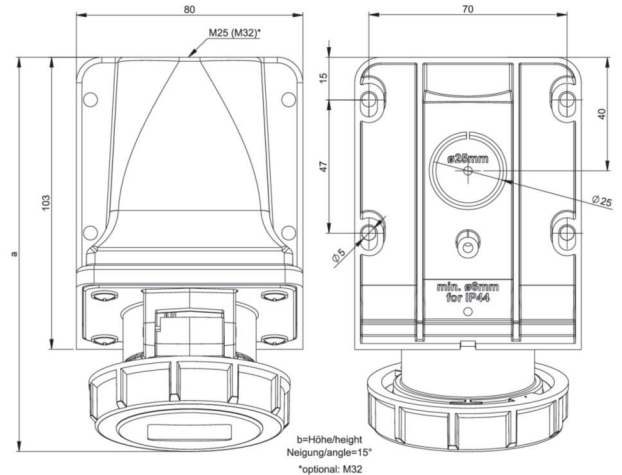





<https://www.pcelectric.at/shop/en/?func=detail&artnr=1932-3v>