

article#	0932-4v
article description	CEE-plug 32A 3p 24/42VAC 100-200Hz IP67 TWIST
description long	CEE-plug 32A 3p 24/42VAC 100-200Hz IP67 TWIST housing material: PA6 rated current: 32A number of poles: 3 (3P) clock-position: 4h rated voltage/frequency: 24/42V~ / 100-200Hz contacts: brass nickel plated connection technology: screw terminals IP protection class: IP67
GTIN (EAN)	9003399113765
country of origin	AT
customs number	85366990
net weight	0.169 kg
packaging quantity	10
minimum order quantity	10

ETIM 9.0	EC000140
IEC-amperage	32 A
Number of poles	3
Voltage according to EN 60309-2	20-25 V / 40-50 V (100-200 Hz) green
Clock hour position	4 h
Identification colour	Green
Degree of protection (IP)	IP67
Connection system	Screwed terminal
Cable entry	Gland nut
Angle of plug	Straight
Material	Plastic
Contact material	CuZn
Surface treatment contacts	Nickel-plated

a	135 mm
b	71 mm
K (cable Ø)	9,5-24 mm
SW	48 mm
wire flexible	1-10 mm ²
contact screws	160 Ncm
strain relief	600 Ncm
dismantling length	70 mm
stripping length	14-16 mm
ambient temperature	-25 – 40 °C
temperature resistance	-25 – 80 °C

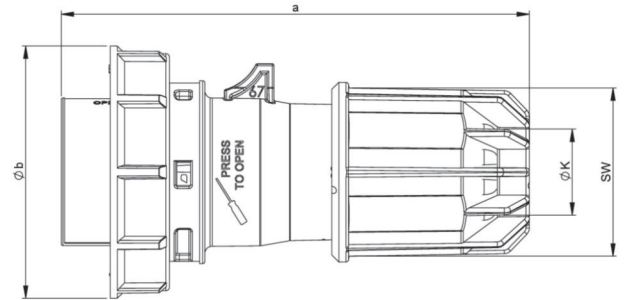

<https://www.pcelectric.at/shop/en/?func=detail&artnr=0932-4v>